

kuchnia gazowa, 6-palnikowa, nastawna, 36.5 kW, G30

Kod katalogowy: 9707230

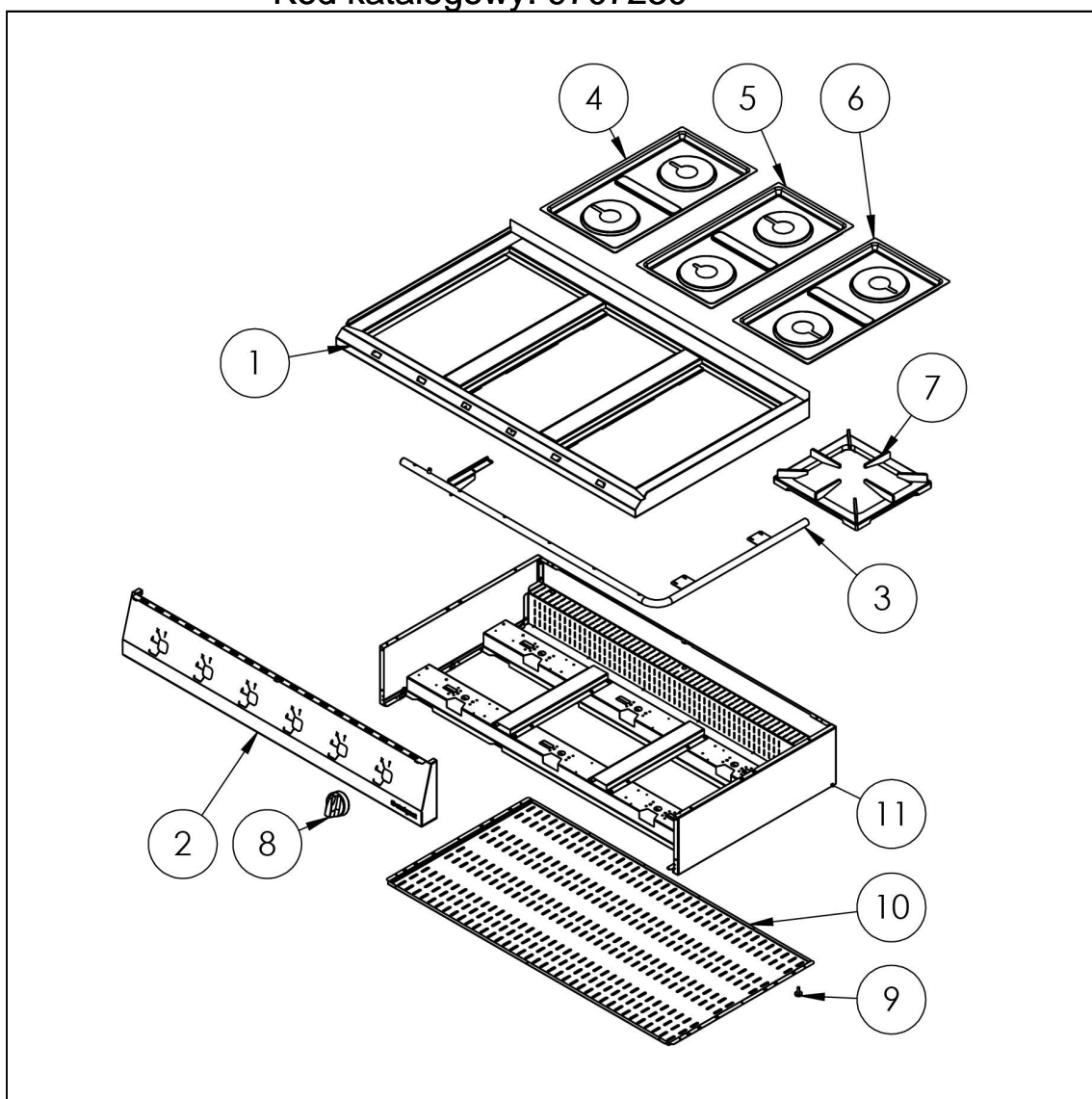

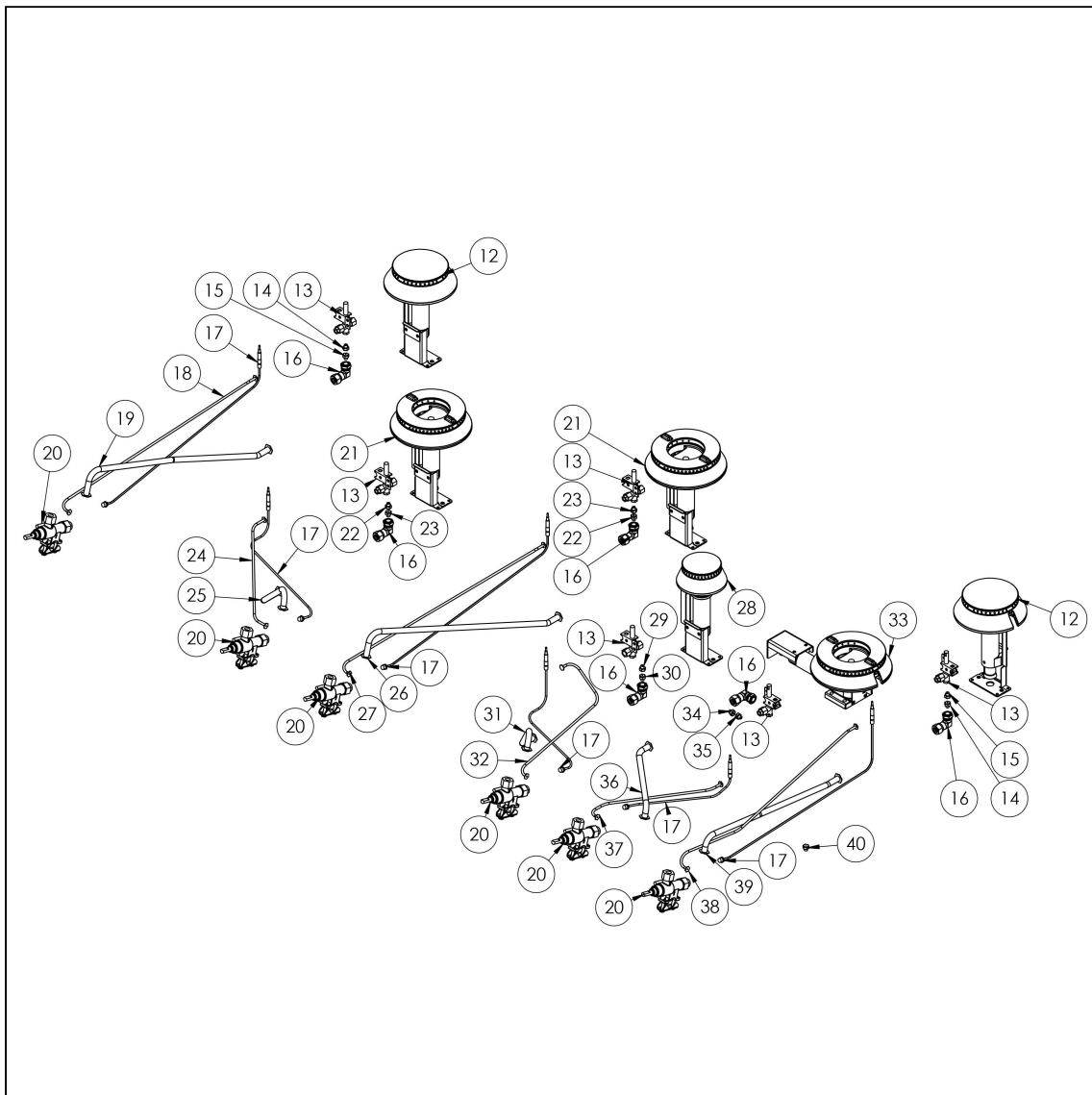

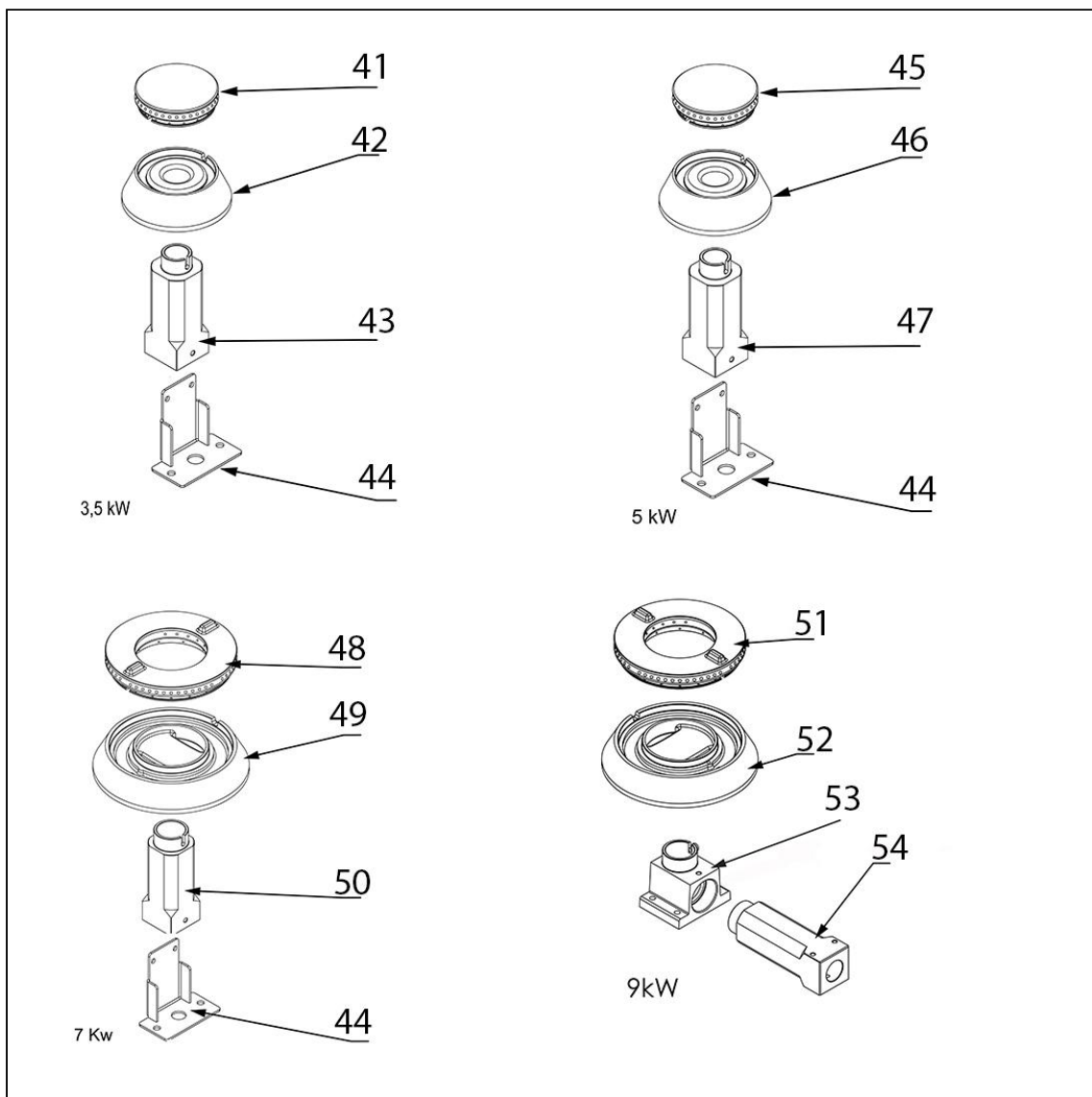

Nr cz ci (V nr rys.-nr cz ci z rysunku)	Nazwa	Kod
V9707230-01	Blat	
V9707230-02	Panel przedni	
V9707230-03	Kolektor	
V9707230-04	Misa lewa	C010870
V9707230-05	Misa rodkowa	C011160
V9707230-06	Misa prawa	C010501
V9707230-07	Ruszt	C009045
V9707230-08	Pokr tło	C011161
V9707230-09	Stopka	C010548
V9707230-10	Oslona dolna	
V9707230-11	Korpus	
V9707230-12	Palnik 5kW	C010849
V9707230-13	Palnik pilota	C008078
V9707230-14	Dysza palnika 5 kW GZ 1.7	C006358
V9707230-15	Dysza palnika 5 kW PB 1.05	C007536
V9707230-16	Kolano	C009080
V9707230-17	Termopara 600	C008081
V9707230-18	Rura miedziana fi6x1	
V9707230-19	Rura miedziana fi10x1	
V9707230-20	Zawór	C008801
V9707230-21	Palnik 7kW	C002407
V9707230-22	Dysza palnika 7 kW GZ 2.0	C007720
V9707230-23	Dysza palnika 7 kW PB 1.2	C007537
V9707230-24	Rura miedziana fi6x1	
V9707230-25	Rura miedziana fi10x1	
V9707230-26	Rura miedziana fi10x1	
V9707230-27	Rura miedziana fi6x1	
V9707230-28	Palnik 3.5kW	C010605
V9707230-29	Dysza palnika 3.5 kW PB 0.9	C007535
V9707230-30	Dysza palnika 3.5 kW GZ 1.35	C007108
V9707230-31	Rura miedziana fi10x1	
V9707230-32	Rura miedziana fi6x1	
V9707230-33	Palnik 9kW	
V9707230-34	Dysza palnika 9kW GZ 2.35	C007721
V9707230-35	Dysza palnika 9 kW PB 1.35	C007108
V9707230-36	Rura miedziana fi10x1	
V9707230-37	Rura miedziana fi6x1	
V9707230-38	Rura miedziana fi6x1	
V9707230-39	Rura miedziana fi10x1	
V9707230-40	Dysza palnika pilota GZ 0.41	C010906
V9707230-41	Korona palnika 3.5kW	C009051
V9707230-42	Korpus palnika 3.5kW	C009052
V9707230-43	In ektor 3.5kW	C009092
V9707230-44	Wspornik podstawy dyszy	C009079
V9707230-45	Korona palnika 5kW	C009053
V9707230-46	Korpus palnika 5kW	C009054
V9707230-47	In ektor 5kW	C010161
V9707230-48	Korona palnika 7kW	C009040
V9707230-49	Korpus palnika 7kW	C009027
V9707230-50	In ektor 7kW	C009168
V9707230-51	Korona palnika 9kW	C009991
V9707230-52	Korpus palnika 9kW	C009992
V9707230-53	Kolano palnika 9kW	C009059
V9707230-54	In ektor 9kW	C009120